

Performance Evaluation of Different Hybrid Optical Amplifiers for 64×10, 96×10 and 128×10 Gbps DWDM transmission system

Rashmi^a, Anurag Sharma^b, Vikrant Sharma^c

a Deptt. of Electronics & Communication Engg., CTIEMT, PTU, Jalandhar, India

b Deptt. of Electronics & Communication Engg., CTIRT, PTU, Jalandhar, India

c Deptt. of Electronics & Communication Engg., CTIT, PTU, Jalandhar, India

Abstract- We have investigated the performance evaluation of different Hybrid Optical Amplifiers (EDFA-SOA, Raman-SOA, Raman-EDFA). The proposed configuration consists of 64, 96 and 128 channels at speed of 10 Gbps. We have realized the different hybrid amplifiers and their parameters like BER, Output Power at different numbers of channels. The different can provide better result and better feasibility for long distance transmission. It is observed that EDFA-SOA showed good performance as it can travel max distance of 100,150,200 and 250 km at 64, 96 and 128 channels respectively.

Keywords: Raman-EDFA, Raman-SOA, SOA-EDFA, EDFA-EDFA, SOA-RAMAN-EDFA, BER.

I. INTRODUCTION

Dense wavelength division multiplexing (DWDM) is basically wavelength division multiplexing (WDM) with small channel spacing. Where different optical signal frequencies are used in order to achieve simultaneous transmission of a definite number of optical channels over a single fiber [1]. The high speed transmission over the global telecommunication network without repeaters will continue to grow at an exponential rate and only optical fiber amplifiers will be able to meet the challenge [2]. It is important to maintain the required level of system performance over a longer transmission distance. Multichannel systems are highly sensitive to optical attenuation and chromatic dispersion and fiber non-linearity [1]. Optical amplifiers are used to maintain the level of the signal. Optical gain depends upon the frequency of the incoming signal. Optical amplifiers are better than regenerators. In Semiconductor Optical Amplifier (SOA) and Erbium Doped Fiber Amplifier (EDFA) amplifier optical gain is provided through stimulated emission, and in the Raman Amplifier (RA) non-linearity is used. In the amplifier medium spontaneous emission occurs, which amplified with the transmitted signal, and hence the amplified spontaneous emission (ASE) noise produce, which affect the total transmission distance [3]. In WDM Semiconductor optical amplifiers (SOAs), doped fiber amplifiers (DFAs), and Raman amplifiers (RA) are used [4]. These amplifiers have their own benefits and drawbacks. SOAs has problem to produce large amount of ASE and gain dynamics cause signal distortions. Doped fiber amplifiers provide amplifications with less signal

impairments than SOA. DFAs gain is highly frequency dependent due to doped material [1]. Raman amplifiers provide noise free amplification. In Raman amplifier spectrum can be changed by using different pumps and their frequencies [5]. To improve the drawbacks of different amplifiers they are used together by forming a hybrid amplifier. In this paper we have designed a DWDM transmission system with different combinations of amplifiers and studied different hybrid amplifiers in different number of channels with 100,150,200 and 250 km distance.

V. Bobrovs *et al.* [1] performed comparison of Raman-SOA and Raman-EDFA hybrid optical amplifier in DWDM transmission systems. In this the combination of EDFA and distributed Raman Amplifier showed better results and provided transmission over a longer optical link than the SOA-Distributed Raman amplifier.

Piyush Jain *et al.* [3] investigated the performance comparison of different hybrid optical amplifiers (RAMAN-EDFA, RAMAN-SOA, SOA-EDFA, EDFA-RAMAN-EDFA). In order to compare performance at 16 and 32 channels at speed of 10 Gbps. These comparisons have been done by varying transmission distance in between 10 to 200 km with dispersion 16.75 ps/nm/km. It is observed that EDFA-RAMAN-EDFA provides better results for output power. In 16 channels system both RAMAN-EDFA & EDFA-RAMAN-EDFA have same value for Q-factor & BER for short distance but for long distance EDFA-RAMAN-EDFA has highest value among all.

Shevta Singh *et al.* [4] demonstrated long haul WDM transmission of 32x10 Gbits/s and 64 x 10 Gbits/s over single mode fiber of 650 km and 530 Km respectively by using RAMAN-EDFA hybrid optical amplifier at inline and preamplifier amplifiers. In this it is observed that before 650 and 530 km BER and Q-factor, Power and eye opening is acceptable and after 650 and 530 km Q-factor and BER increases.

Simranjit Singh *et al.* [5] demonstrated using hybrid configuration with a distributed Raman amplifier and

EDFA for 160 x 10 Gb/s DWDM system at 25 GHz. Hybrid optical amplifier proposed using two configurations. And it is observe that when input power increases gain over the bandwidth also increases. This technique is cost effective technique for flattening the gain. Sameksha Bhaskar et al. [6] has investigated the performance comparison of different hybrid optical amplifiers such as RAMAN-EDFA, RAMAN-SOA, SOA-EDFA, EDFA-RAMAN-EDFA. The analysis has been done on the basis of different channels such as 16, 32 and 64 channels at the speed of 10 Gbps. They observed parameters like Q-factor, BER, eye opening and jitter at different number of channels. Different combinations provide different results. SOA-EDFA showed good performance because it can travel max distance of 220, 240, 260 km at 16, 32 and 64 channels respectively. Raman-EDFA showed a good performance as it has high Q-factor and BER at 16 channels.

This paper is divided into different sections for different Hybrid Optical Amplifiers for 64x10, 96x10 and 128x10 Gbps DWDM transmission system. In section 2, the simulation set up for the transmission of 64, 96 and 128 channels at 10 Gb/s speed. Section 3 gives the discussion of the results observed after the simulation. And section 4 gives the conclusion of the system performance.

II. SIMULATION SETUP

In the figure shown below, 64, 96 and 128 channels are transmitted at 10 Gb/s speed with 0.4nm channel spacing. DWDM transmission system designed on simulation Software Opt sim 5.2. Input signals pre-amplified by a booster and these signals are transmitted over optical fiber by different transmission distances. A transmitter consists

of the PRBS data source, NRZ electrical driver. CW laser source and external Mach-Zehnder modulator are consisted by transmitter section. Electrical driver converts the logical input signal into an electrical signal. The CW laser source generates the laser beam at 187-190.975THz with 0.4nm channel spacing. Optical signal is transmitted and measured over different distance for 100,150,200 and 250 km at 0.09ps/nm/km dispersion. The modulated signal is converted into original signals with the help of PIN photodiode and filters. Receiver is used to detect all signals and converts these into electrical form. Different types of optical amplifiers are also applied at the receiver side. The simulation is repeated for measuring the signal strength by using different hybrid amplifiers i.e. EDFA-SOA, RAMAN-EDFA, RAMAN-SOA. For all the cases BER has been evaluated.

For Single Mode Fiber (SMF) reference frequency is 1550nm and attenuation is 0.25dB/km. In this paper the various parameters of SOA are biased current is 100mA.insertion loss is 3dB and output insertion is 3 dB. Various parameters of EDFA are length 5 meters, numerical aperture 0.24. Various parameters for RAMAN are Raman fibre length is 10 km, operating temperature is 300 K pump wavelength is 1480 nm and pump power is 300 mW.

III. RESULTS AND DISCUSSIONS

The Performance and results of above DWDM transmission System are shown below. Fig. 2 shows the spectrum of 64 channels multiplexed signal. This multiplexed Signal is in between 1550nm to 1575nm with 0.4nm channel Spacing.

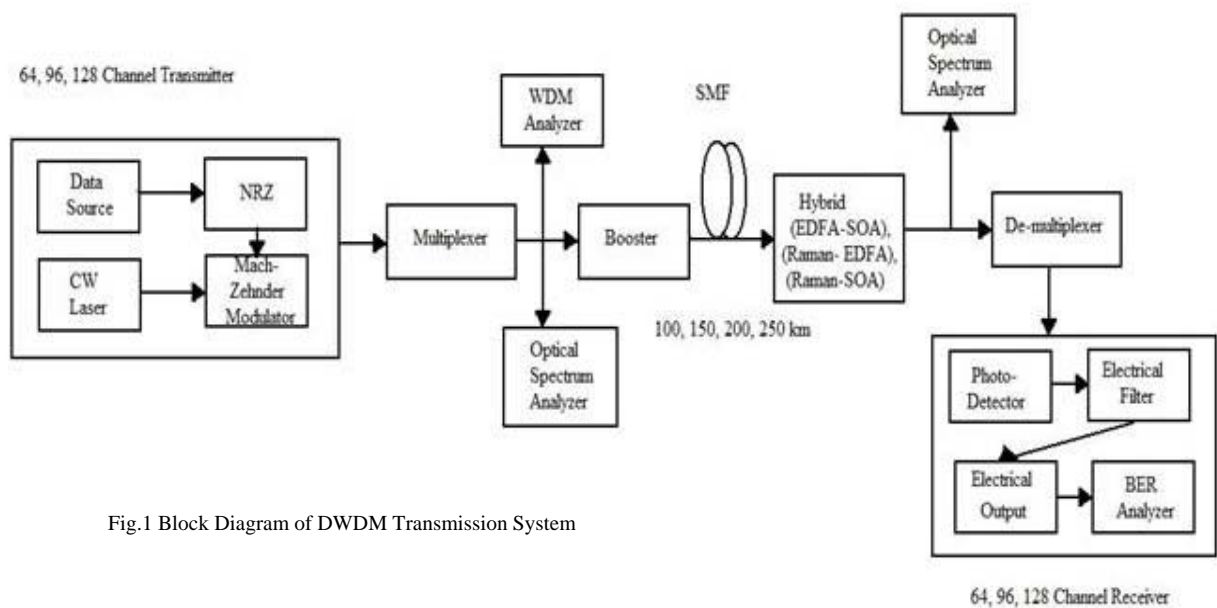

Fig.1 Block Diagram of DWDM Transmission System

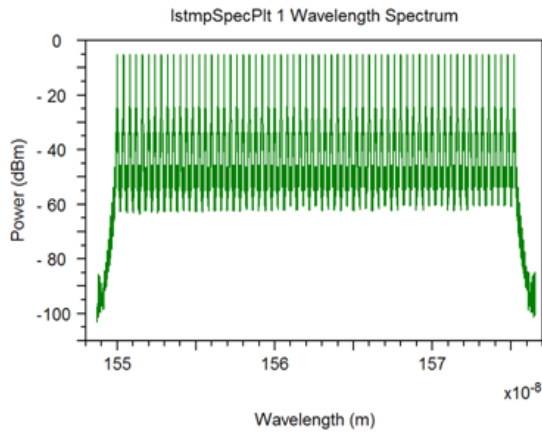

Fig.2 64 channel spectrum

The above 64 channel multiplexed signal go through booster and then cross the single mode fiber. Fig.3 shows the spectrum of 64 channels after crossing span length of 150 km.

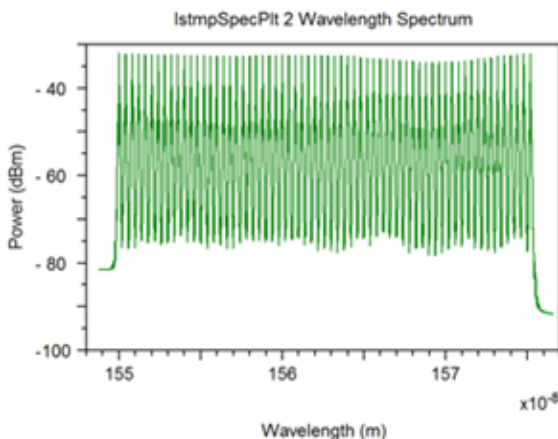

Fig. 3 64 Channel spectrum after crossing 150 Km

After crossing the span length of single mode fiber the signal enter into the hybrid amplifier. Fig. 4 shows the 64 channel spectrum after passing the combination of EDFA-SOA.

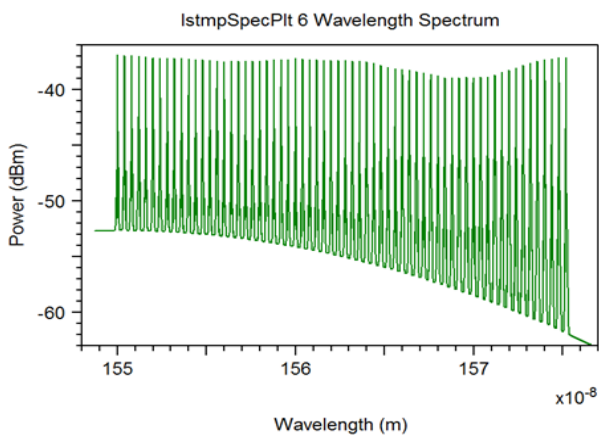

Fig.4 64 channel spectrum after crossing EDFA-SOA After getting amplified by hybrid amplifier spectrum move towards demultiplexer. Fig.5 shows the spectrum which will be received by the receiver.

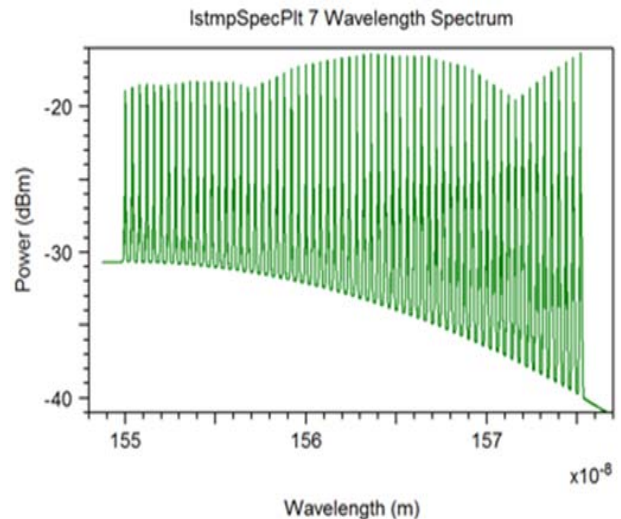

Fig.5 64 channel spectrum received at receiver

The Performance of different hybrid amplifiers EDFA-SOA, RAMAN-EDFA, RAMAN-SOA are evaluated and compared for 64 x 10 Gbps, 96 x 10 Gbps, 128 x 10 Gbps DWDM system in term of received output power, minimum BER at different transmission distance. The distance from 100 to 250 km in steps of 50 Km. As we increase the distance output power decreases simultaneously. To analyze the system, the results of the middle channel have been taken. As we increase the transmission distance from 100 km to 250 km, the output power decreases and BER increases. The variation in different hybrid amplifiers at distance 100 km is 10^{-24} for

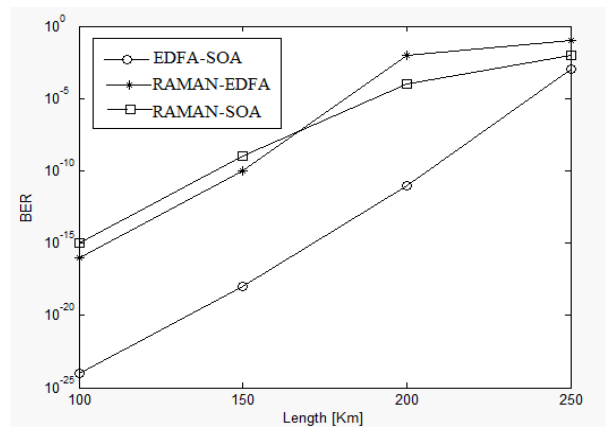

Fig. 5 BER vs. Length for 64 X 10 Gbps

EDFA-SOA, 10^{-16} for Raman-EDFA, and 10^{-15} for RAMAN-SOA for 64 channels as shown in Fig.5. That shows there is no distortion in the detected signal. The variation in Output power for different Hybrid optical amplifier at distance 100 km to 250 km is 13.97 dBm for EDFA-SOA, 12.90 dBm for RAMAN-EDFA, 7.2 dBm for RAMAN-SOA for 64 channels as shown in Fig.6.

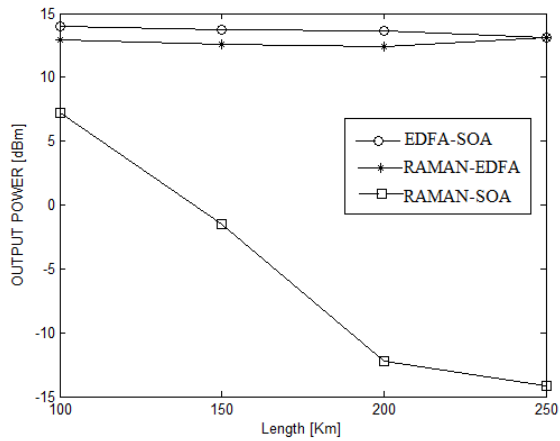

Fig. 6 Output power vs. Length for 64 X 10 Gbps

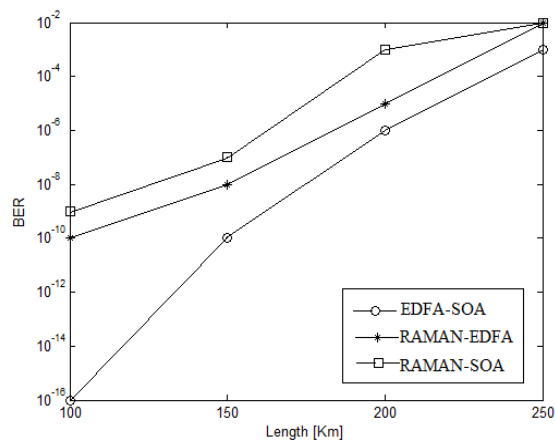

Fig. 7 BER vs. length for 96 X 10 Gbps

In order to observe the performance of different hybrid amplifiers, the length vs. BER are shown in Fig.7 for 96 channels DWDM transmission system. The graph shows that as we increase the transmission distance from 100 km to 150 km, the BER increases simultaneously. The BER increases from 10^{-16} for EDFA -SOA, 10^{-10} for Raman-EDFA, 10^{-9} for Raman-SOA. The variation in Output power for different hybrid optical amplifier at different distance 100 km to 250 km is 14.92 dBm for EDFA-SOA, 12.90 dBm for RAMAN-EDFA, 5.32 dBm for RAMAN-SOA. for 96 channels as shown in Fig.8.

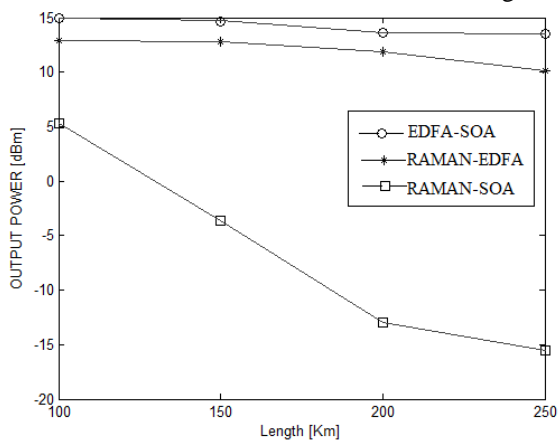

Fig. 8 Output power vs. Length for 96 X 10 Gbps

In order to observe the BER of different hybrid amplifiers for different distance from 100 km to 250 km for 128 channels is 10^{-12} for EDFA-SOA, 10^{-8} for RAMAN-EDFA, 10^{-7} for RAMAN-SOA. for 128 channels as shown in Fig.9. The variation in output power for different Hybrid optical amplifier at distance from 100 km to 250 km is 15.55 dBm for EDFA-SOA, 11.80 dBm for RAMAN-EDFA and 4.44 for RAMAN-SOA as shown in Fig.10.

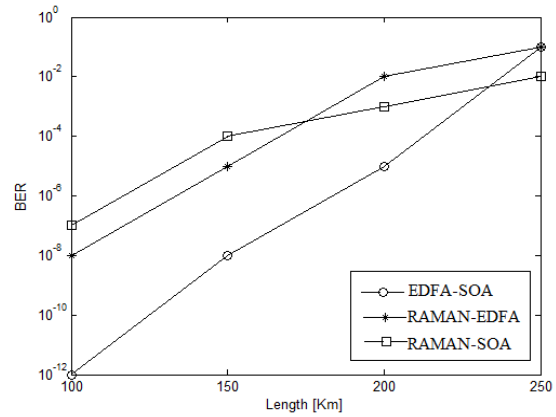

Fig. 9 BER vs. Length for 128 channels

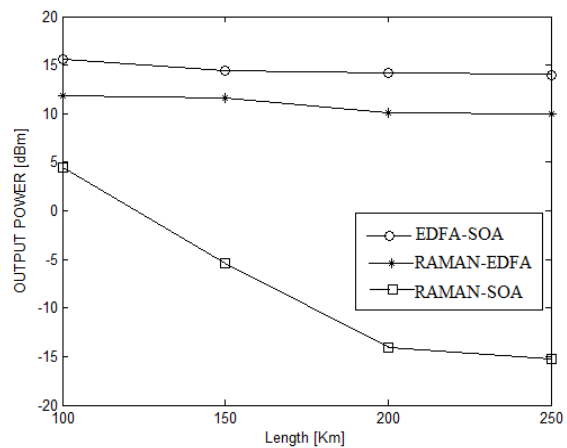

Fig. 10 Output power vs. length for 128 channels

IV. CONCLUSION

The performance of different hybrid amplifiers is compared at different distances. The results shown that the combination of EDFA-SOA shows good performance and it increase the maximum reachable distance. EDFA-SOA showed good performance at all the channels as it can go up to maximum distance. The proposed configuration consists of 64, 96 and 128 channels. Hybrid EDFA-SOA are enabling and promising for future as it can travel the maximum distance.

REFERENCES

- [1] V. Bobrovs, S. Olonkins, A. Alsevska, L. Gegere and G. Lvanovs, "Comparative performance of Raman-SOA and Raman-EDFA hybrid optical amplifiers in DWDM transmission systems," International Journal of Physical Sciences, Vol 8, Issue 39, October 2013, Pg 1898-1906.
- [2] Anil Agarwal, Sudhir Kumar Sharma, "Performance Comparison of Single & Hybrid Optical Amplifiers for DWDM System Using Opti system," IOSR Journal of Electronics and Communication Engineering, Vol 9, Issue 1, Ver VI, February 2014, Pg 28-33.

- [3] Piyush Jain, Mr. Bipin Koushal, Shrija Jain, "Performance analysis of different Hybrid optical amplifier due to varying Transmission distance at 10 Gbps," International Journal of Emerging Technologies in Computational and Applied Sciences (IJETCAS), Vol 13, Issue 347, 2013, Pg 246-250.
- [4] Shveta Singh, M.L Sharma, "32 x 10 and 64 x 10 Gb/s transmission using hybrid Raman-Erbium doped optical amplifiers," International Journal of Advanced Computer Science and Applications, Special Issue on Wireless & Mobile Networks, Pg 76-80.
- [5] Simranjit Singh, R.S kaler, "Flat-Gain L-Band Raman-EDFA Hybrid Optical Amplifier for Dense Wavelength Division Multiplexed System," IEEE Photonics Technology Letters, Vol 25, No.3,1 February 2013,Pg 250-252.
- [6] Sameksha Bhaskar, M.L Sharma, "Performance Comparison of Different hybrid amplifiers for different numbers of channels," International Journal of advanced Computer Science and Applications, Special Issue on Wireless & Mobile Networks, Pg 19-25.
- [7] Mahmud Wasfi, "Optical Fiber Amplifiers-Review," International Journal of Communication Networks and Information Security (IJCNIS), Vol 1, April 2009.
- [8] Simranjit Singh, R.S kaler, "Flat-Gain L-Band Raman-EDFA Hybrid Optical Amplifier for Dense Wavelength Division Multiplexed System," IEEE Photonics Technology Letters, Vol 25, No. 3, February 1,2013.
- [9] Juliano Rodrigues Fernandes de Oliveira,Uiara Celine de Moura, Getulio Eduardo Rodrigues de Paiva, Alexandre Passos de Freitas, Luis Henrique Hecker de Carvalho, Victor Emanuel Parahyba, Julio Cesar Rodrigues Fernandes de Oliveira and Murilo Araujo Romero, "Hybrid EDFA/Raman Amplification Topology for Repeaterless 4.48 Tb/s (40 x 112 Gb/s DP=QPSK) Transmission Over 302 Km of G.652 Standard Single Mode Fiber," Journal of Lightwave Technology, Vol 31, No. 16, August 15, 2013, Pg 2799-2808.
- [10] Gordon K. P. Lei, M.E. Marhic, "Performance Investigation of a hybrid fiber optical parametric amplifier," Optic Express, Vol 21, No.19, 23 Aug 2013, Pg 21932-21940.
- [11] A. Carena, V. Curri, P. Poggiolini, "On the Optimization of Hybrid Raman/Erbium-Doped Fiber Amplifiers," IEEE Photonics Technology Letters, Vol 13, No. 11, November, 2001, Pg 1170-1172.
- [12] Tetsufumi Tsuzaki, Michiko Harumoto, Motoki Kakui, Kozo Fujii, " 3.2Tb/s-1,500 km WDM transmission experiment using 64nm hybrid repeater amplifiers," Vol.4, 2000, Pg 239-241.